

Vakuum-Sauger

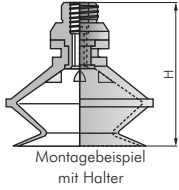
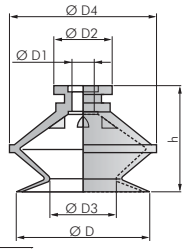

Balgsauger, 1,5-fach P-Serie (Ø 20 - 50 mm)

Typ CR (schwarz)	Typ Silikon (transparent)	Anschluss		D	Hub	IG/AG	D1	D2	D3	D4	h	H	Haltertyp
		D	Hub										
VSP 20 B1 CR	VSP 20 B1 Si	20	9	M5/G1/8"	5,5	14,5	11	24	20	29,5	C		
VSP 30 B1 CR	VSP 30 B1 Si	32	9	M5/G1/8"	5,5	14,5	17	36	26	35,6	C		
VSP 40 B1 CR	VSP 40 B1 Si	42	9	G1/8"-	6,5	20,0	24	46	28	36,0	D		
VSP 50 B1 CR	VSP 50 B1 Si	52	12	G1/8"-	10,5	27,0	31	58	35	44,0	E		

passende Halter (muss separat bestellt werden)

Typ Aluminium	Typ Haltering (optional)	Gewindeanschluss	DN	Haltertyp
VSPH C18	VSPH C18 HR	M5 IG / G 1/8" AG	3,1	C
VSPH D18 i	VSPH D18 i HR	G 1/8" IG	5,2	D
VSPH E18 i	VSPH E18 i HR	G 1/8" IG	6,3	E

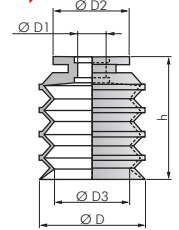
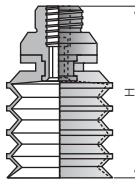

Balgsauger, 4,5-fach P-Serie (Ø 20 - 50 mm)

Typ CR (schwarz)	Typ Silikon (transparent)	Anschluss		D	Hub	IG/AG	D1	D2	D3	h	H	Haltertyp
		D	Hub									
VSP 20 B4 CR	VSP 20 B4 Si	20	16	M5/G1/8"	5,0	14,5	14	23	32,5	C		
VSP 30 B4 CR	VSP 30 B4 Si	30	21	G1/8"-	6,5	20,0	21	32	41,0	D		
VSP 40 B4 CR	VSP 40 B4 Si	40	20	G1/8"-	6,5	20,0	28	42	50,0	D		
VSP 50 B4 CR	VSP 50 B4 Si	50	30	G1/8"-	10,5	27,0	35	51	60,0	E		

passende Halter (muss separat bestellt werden)

Typ Aluminium	Typ Haltering (optional)	Gewindeanschluss	DN	Haltertyp
VSPH C18	VSPH C18 HR	M5 IG / G 1/8" AG	3,1	C
VSPH D18 i	VSPH D18 i HR	G 1/8" IG	5,2	D
VSPH E18 i	VSPH E18 i HR	G 1/8" IG	6,3	E

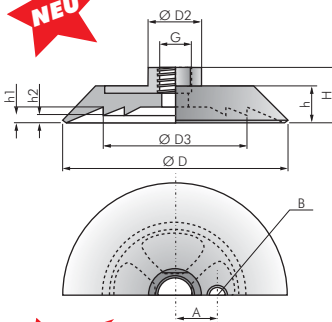

Flachsauger mit Standardlippe und einvulkanisiertem Halter Ø 30 - 225 mm

Anwendung: Universalsauger, Doppelsicherheitslippe verhindert Abreißen bei Leckverlust der äußeren Lippe

Typ CR (60A) (schwarz)	Typ Silikon (60A) (rot)	G		D	Hub	(IG)	D2	D3	h	H	h1	h2	A	B	DN
		D	Hub												
VS 30 FK CR*	VS 30 FK Si	30	2,5	M 5	10	18	10	17	3,5	2,5	---	---	---	---	3,2
VS 50 FK CR*	VS 50 FK Si	50	4,0	G 1/8"	18	33	11	18	5,5	4,5	---	---	---	---	8,8
VS 75 FK CR	VS 75 FK Si	75	5,5	G 1/4"	22	50	15	23	7,0	5,5	---	---	---	---	11,8
VS 100 FK NBR ³ **	VS 100 FK Si ² **	100	10,0	G 3/8"	30	68	20	30	15,5	9,5	---	---	---	---	15,2
VS 150 FK CR ³	VS 150 FK Si ³	150	10,0	G 1/2"	35	100	26	42	12,0	9,0	30	G 1/8"	19,0		
VS 225 FK CR ³	VS 225 FK Si	225	8,0	G 3/4"	50	150	34	54	14,0	11,0	50	G 1/8"	24,5		

¹Werkstoff: NBR schwarz, ²transparent, ³hellgrau, * Shorehärte: 55A, ** Shorehärte: 50 A

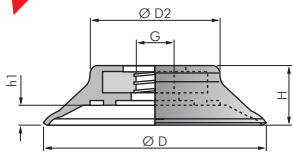

Flachsauger mit stabiler Lippe und einvulkanisiertem Halter Ø 60 - 95 mm

Anwendung: ebene, glatte Flächen

Typ NBR (schwarz)	Typ Silikon (transparent)	G		D	Hub	(IG)	D2	H	h1	DN
		D	Hub							
VS 60 FSK NBR	VS 60 FSK Si	60	5	G 1/4"	38,5	16	5	11,8		
VS 80 FSK NBR	VS 80 FSK Si	80	6	G 1/4"	53,0	18	6	11,8		
VS 95 FSK NBR	VS 95 FSK Si	95	6	G 1/4"	68,0	19	6	11,8		

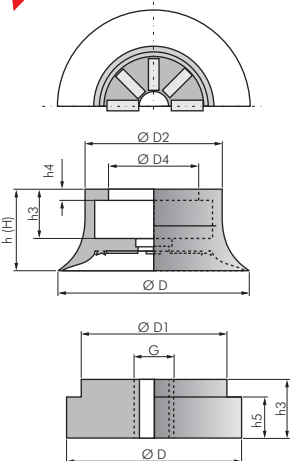

Flachsauger mit sehr feiner Lippe Ø 40 - 200 mm

Anwendung: unebene, strukturierte und sehr raue Flächen, z.B. Riffelblech

Typ	Anschluss		H (inkl. Halter)			Werkstoffe	verfügbare Haltertyp				
	D	Hub	IG	D2	D4						
VS 40 FF **	40	3	G 1/8"	26	17,0	12,5	6	3	○ ●	L	
VS 70 FF **	70	6	G 1/4"	50	32,5	30,0	18	4	● ○ ●	M	
VS 100 FF **	100	5	G 1/4"	70	50,5	32,0	33,0	19	● ○ ●	N	
VS 200 FF NRE	200	5	G 1/2"	170	148,0	32,0	34,0	18	5	● ○ ●	P

passende Halter (muss separat bestellt werden)

Typ Aluminium	D	D1	h3	h5	G (IG)	DN	Haltertyp
VSH L18 i	20	17,5	6	3,0	G 1/8"	8,5	L
VSH M14 i	43	32,0	20	14,3	G 1/4"	11,8	M
VSH N14 i	60	50,0	20	14,0	G 1/4"	11,8	N
VSH P12 i	160	150,0	20	14,0	G 1/2"	19,0	P

¹45 Shore A, ²40 Shore A, ³35 Shore A

Bestellbeispiel: VS 40 FF **

Standardtyp

- Bestellzusatz für den Werkstoff:**
- Buna rotbraun-SBR
 - NBR grau-NBR
 - Silikon transparent-SI
 - Naturkautschuk beige . . .-NR
 - Naturkautschuk braun . .-NRE

Alle Angaben verstehen sich als unverbindliche Richtwerte! Für nicht schriftlich bestätigte Datenauswahl übernehmen wir keine Haftung. Druckangaben beziehen sich, soweit nicht anders angegeben, auf Flüssigkeiten der Gruppe II bei +20°C.