

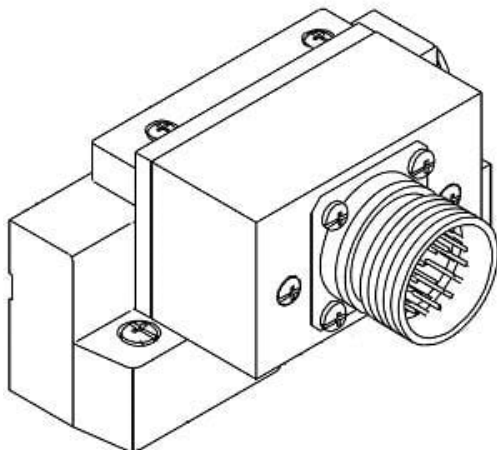

Płyta końcowa EX500 IP67 (SV1000-51D-30A-C8) - SMC



**Numer artykułu SKU:
SV1000-51D-30A-C8**

Numer artykułu producenta:

Czas wysyłki: 5 tygodni



OPIS PRODUKTU

DANE TECHNICZNE

Nr kat.

SV1000-51D-30A-C8