

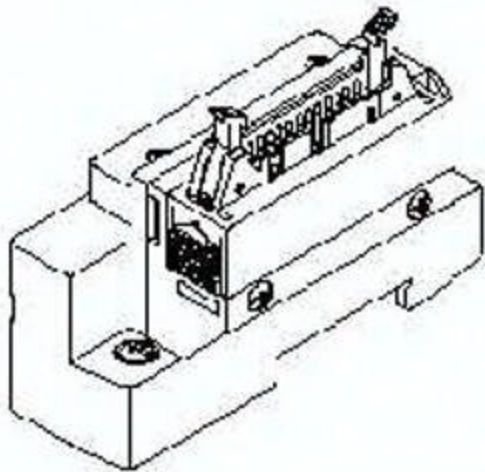

Płyta końcowa strona D SV2000-51D2-34AR-C10, SMC



**Numer artykułu SKU:
OT-SMC060556**

Numer artykułu producenta:

Tylko na zamówienie



OPIS PRODUKTU

SV2000-51D2-34AR-C10 SV2000-51D2-34AR-C10 SMC Endplatte D-Seite Flachb.

DANE TECHNICZNE

Nr kat.

OT-SMC060556