

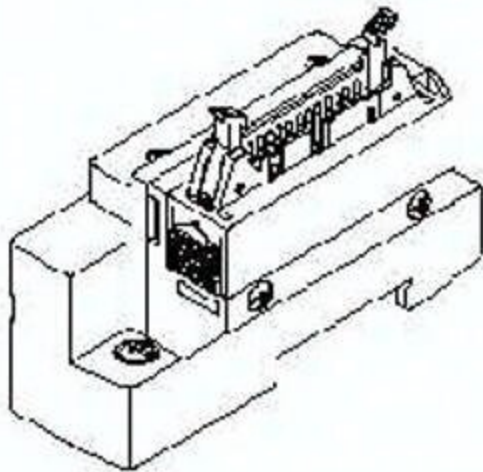

## Płyta końcowa strona D SV1000-51D1-34AR-C8, SMC



**Numer artykułu SKU:  
OT-SMC060190**

Numer artykułu producenta:  
-----

Tylko na zamówienie



## OPIS PRODUKTU

SV1000-51D1-34AR-C8 SV1000-51D1-34AR-C8 SMC Endplatte D-Seite Flachb.

## DANE TECHNICZNE

Nr kat.

OT-SMC060190