

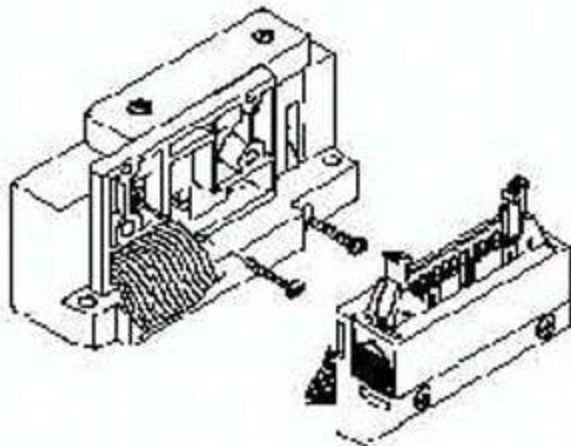

Płyta końcowa strona D SV1000-51D2-14AR-C8, SMC



**Numer artykułu SKU:
OT-SMC060204**

Numer artykułu producenta:

Tylko na zamówienie



OPIS PRODUKTU

SV1000-51D2-14AR-C8 SV1000-51D2-14AR-C8 SMC Endplatte D-Seite Flachb.

DANE TECHNICZNE

Nr kat.

OT-SMC060204