

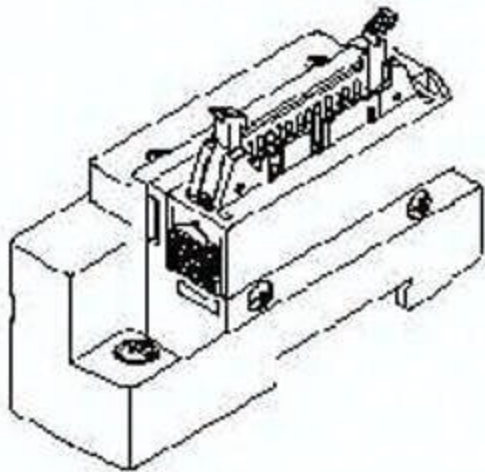

Płyta końcowa strona D SV1000-51D2-34A-00, SMC



**Numer artykułu SKU:
OT-SMC060212**

Numer artykułu producenta:

Tylko na zamówienie



OPIS PRODUKTU

SV1000-51D2-34A-00 SV1000-51D2-34A-00 SMC Endplatte D-Seite Flachb.h

DANE TECHNICZNE

Nr kat.

OT-SMC060212