

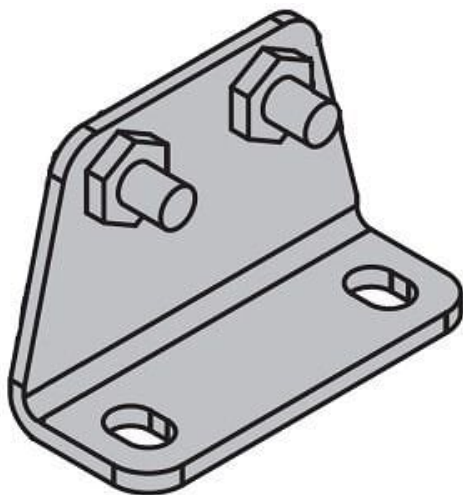

## Wspornik L do siłownika AS2052F (AS-25L) - SMC



**Numer artykułu SKU:  
AS-25L**

Numer artykułu producenta:  
-----

Czas wysyłki: Do 3-5 dni



### OPIS PRODUKTU

## Dane techniczne

Do serii 25 (Do AS2052F)

### DANE TECHNICZNE

Nr kat.	AS-25L
---------	--------