

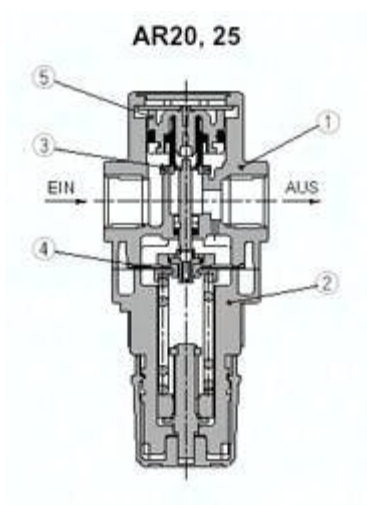

Tłok (AR40P-520AS-N-X425) - SMC



**Numer artykułu SKU:
AR40P-520AS-N-X425**

Numer artykułu producenta:

Tylko na zamówienie



OPIS PRODUKTU

DANE TECHNICZNE

Nr kat.

AR40P-520AS-N-X425